

Safety Instructions

**WARNING !!!**

Know the capacity and limitations of your machine. Do not overload the lift truck or the attachment. Please note that the rated capacity of the truck/attachment combination may be less than the capacity shown on the attachment nameplate. The lift truck manufacturer is responsible for calculating the rated capacity for the combination. See the lift truck nameplate.

**WARNING !!!**

Never stand on the forks or on the load

**WARNING !!!**

Never stand under a load or attachment.

**WARNING !!!**

Never stand in the attachment operating area or between the forks.

WARNING !!!

Limit driving with a raised load to the minimum. Never accelerate or brake powerfully with a raised load.

WARNING !!!

Handle only those products which the attachment has been designed for. It is unsafe to lift any other objects.

WARNING !!!

Do not risk the lift truck stability by sideshifting. Sideshift only when the load is lowered down or near its seat. Use extreme caution when handling off-centered loads.

WARNING !!!

Always check the operating condition of the attachment before use. Never use a defective or damaged attachment. Repairs may be done by authorized personnel only.

Contents

1. General	4
1.1 Notices	
1.2 Safety Instructions	
2. General Information	5
3. Installation Instructions	6
3.1 Lift Truck Requirements	
3.2 Handling and Storage	
3.3 Installation	
3.4 Hose Flush	
3.5 Connecting the Hoses	
3.6 Hydraulic Connections	
3.7 Hydraulic Connection Options, Opening Relief Valve	
3.8 Air Removal	
3.9 Checks Before Operating the Clamp	
4. User Instructions	15
4.1 General Instructions	
4.2 Short Arm Operation (Model AM-RH Only)	
4.3 Paper Roll Handling	
4.4 Tips for Safe Operation	
5. Periodic Maintenance	19
5.1 Daily Checks	
5.2 Inspection and Service	
5.3 Tightening the Bolts	
5.4 Lubricants	
6. Hydraulic System & Trouble Shooting	22
6.1 General	
6.2 Safety Warnings	
6.3 Hydraulic System: B-Series	
6.5 Trouble Shooting	
7. Service and Repairs	29
7.1 General	
7.2 Notes on Service Actions	
7.3 Service Instructions	
8. Spare Parts	32
8.1 Spare Parts Book	
8.2 Ordering Spare Parts	

1. General

This manual contains installation, maintenance and service instructions for standard Bolzoni Auramo AM Series clamp attachments.

Please read this manual carefully before using or servicing this equipment. In this way, you will ensure safe and error-free operation of the clamp attachment right from the start.

Make sure that you know how the clamp works before you attempt to use it.

Every country has its own safety regulations concerning lift trucks and lift truck attachments. It is the responsibility of the user to know and follow these regulations. If safety recommendations given in this manual should differ from your local regulations, you should always follow the local regulations.

1.1 Notices

You will find three different levels of notices in this manual:

WARNING !!! - These paragraphs contain information that will help you prevent injuries.

CAUTION !!! - These paragraphs contain information that will help you prevent damage to the equipment.

NOTE !!! These paragraphs contain information that will help you service the equipment.

1.2 Safety Instructions

Always check the operating condition of the clamp attachment before use. Never use a defective or damaged attachment.

Never stand under a load or clamp attachment.

Never stand in the clamp operating area or between the clamping surfaces.

Handle only those products which the clamp attachment has been designed for. It is unsafe to lift any other objects.

Know the capacity and limitations of your machine.

2. General Information

Series AM paper roll clamps are designed for vertical and horizontal handling of single paper rolls.

All series AM clamps have the following properties in common:

- Pivoting arm movement
- Short and long arm
- 360-degree rotation

Models AM-RF have fixed short arm. This makes the clamp design simple and cost-effective.

Models AM-RH have hydraulically positionable short arm. Positionable short arm enables smaller minimum roll diameters. Short arm positioning is possible in a 45-degree rotation angle.

Model AM-RF

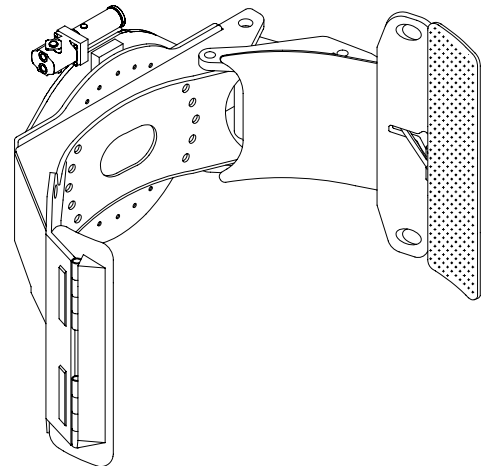

Model AM-RH

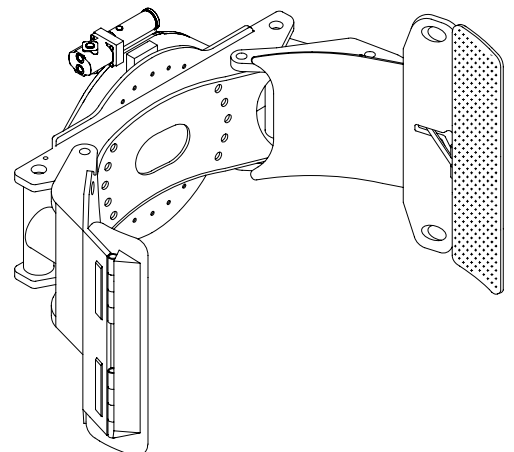

3. Installation Instructions

3.1 Lift Truck Requirements

Attachments reduce the lift truck rated capacity. The lift truck capacity must be re-rated when an attachment is selected.

WARNING !!!

Never use the lift truck & attachment combination to lift more than its rated capacity, as stability factors will be changed. The lift truck may become unsafe.

3.1.1 Clamp Attachment Rated Capacity

Rated Capacity

The rated capacity given for each clamp is a nominal value defined by the clamp construction and clamping force. Rated capacity does not take into consideration properties of the load or working conditions.

Therefore, the net working capacity of a truck-clamp combination is not a fixed value. It is defined by the clamp rated capacity and the truck rated capacity at certain heights, loads and working conditions.

Net Capacity

The lift truck dealer or manufacturer must calculate the net working capacity for the lift truck-clamp combination.

WARNING !!!

Clamp attachment decreases the lift truck rated capacity.

WARNING !!!

The truck is dangerous to the driver and to persons working near the truck if the driver does not know the net working capacity.

Net capacity information must always be visible from the driver's seat.

WARNING !!!

The lift truck manufacturer is responsible for giving the final capacity rating to the forklift/attachment combination.

3.1.2 Hydraulic Pressure and Oil Flow Recommendations

Hydraulic pressure recommendations

Model	Clamping Pressure		Clamping Connection Pressure	Rotation Pressure		Rotation Connection Pressure
	Min. MPa	Max. MPa		Min. MPa	Max. MPa	
AM-13RF/RH ... AM-18RF/RH	X	16.0	16.0	10.0	12.0	25.0

Model	Clamping Pressure		Clamping Connection Pressure	Rotation Pressure		Rotation Connection Pressure
	Min. psi	Max. psi		Min. psi	Max. psi	
AM-13RF/RH ... AM-18RF/RH	X	2,320	2,320	1,450	1,740	3,630

Oil flow rate recommendations

Oil flow rate recommendations						
Model	Oil Flow Rate, Clamp			Oil Flow Rate, Rotator		
	Min. l/min	Recomm. l/min	Max. l/min	Min. l/min	Recomm. l/min	Max. l/min
AM-13RF/RH ... AM-18RF/RH	20	35	45	25	35	45

Oil flow rate recommendations						
Model	Oil Flow Rate, Clamp			Oil Flow Rate, Rotator		
	Min. GPM	Recomm. GPM	Max. GPM	Min. GPM	Recomm. GPM	Max. GPM
AM-13RF/RH ... AM-18RF/RH	5	9	12	5	9	12

If the lift truck produces more hydraulic pressure than what is allowed to any of the unprotected functions of the attachment, separate pressure relief valves must be installed into the lift truck or attachment hydraulic system.

WARNING !!!
Never exceed the maximum connection and operating pressures.

3.1.3 Hydraulic Oils

Use petroleum-based hydraulic oil as recommended by the truck manufacturer.

If you wish to use aqueous-based or biohydraulic oils, please contact Bolzoni Auramo.

3.1.4 Hydraulic Functions

Standard Bolzoni Auramo AM Series clamps require two (2) hydraulic functions from the lift truck hydraulic system in order to enable clamping and rotation.

3.2 Handling and Storage of the Clamp Attachment

Prior to installation, check the clamp carefully to ensure that no damage occurred during transportation.

3.2.1 Lifting the clamp

If you have to lift the clamp during installation, make sure that the capacity of your lifting device is adequate for the load.

WARNING !!!

Never go under a hanging load. Beware of load swing when lifting.

3.2.2 Long Period Storage

If, for any reason, the clamp has to be stored for an extended period, follow the instructions given below in order to prevent damage caused by corrosion:

- Clean the clamp carefully
- Lubricate and grease all parts that require lubrication (see Chapter 5 for instructions).
- Protect all parts that might corrode with a suitable corrosion inhibitor or grease.
- Move arms to a totally closed position (so that the piston rods are completely inside the cylinders).
- Protect the clamp from the effects of the weather. Store it inside or under a proper cover.
- Check the condition of the clamp during storage and, if possible, regularly run all hydraulic functions of the clamp several times.

3.3 Installation

Before installation carry out the following checks:

- Make sure that the lift truck fulfills all clamp requirements (Section 3.1).
- Check that the clamp mounting type is the same as the one used on the truck.
- Check that the lift truck hydraulic oil level is correct.
- Check that the lift truck auxiliary hosing and fittings are in good condition.

- Clean the fork carriage. Make sure that it has no defects or wear that could prevent the installation or use of the clamp attachment.

3.3.1 Installation, Standard Carriages

Installation to the most common standard fork carriages (types ISO 2328-2) is as follows:

- Remove the lower mounting hooks.
- Lift the clamp to the carriage, so that it hangs from the upper mounting hooks. Ensure that the center locator tooth is well positioned into the center notch of the lift truck carriage.
- Install the lower mounting hooks. Tighten the screws with a torque of 80 to 120 Nm.

WARNING !!!

Upper mounting hooks must be properly engaged on the upper carriage bar before fastening lower mounting hooks. If not properly engaged, the clamp can drop.

3.4 Hose Flush

Flush the truck mast hosing before you connect it to the clamp attachment. It is estimated that up to 80% of all defects in hydraulic systems are caused by dirty hydraulic oil. Oil from the mast hoses should be run through the oil filter during the flushing to minimize the amount of debris and dirt in the hoses.

- Connect each hose pair with suitable fittings. If needed, use an extra hose.
- Turn the truck on and actuate control valves in both directions for about 40 seconds.

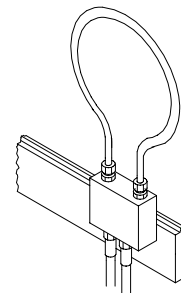

Figure: An example of a hose-flush connection

NOTE !!!

Hose flushing reduces the service costs in the long run!

3.5 Connecting the Hoses

Dimensions of the lift truck mast hoses and other hydraulic components must be adequate to meet the needs of a clamp attachment. In this way there is no excessive power loss or damage caused by oil overheating. Whenever possible, avoid 90-degree fittings as these cause large pressure loss.

Connect the hoses as required by the safety rules: clamping function by pulling the clamping lever, opening function by pushing the clamping lever, rotation clockwise by pulling the rotation lever, rotation counterclockwise by pushing the rotation lever.

Standard connection fitting sizes: AM Series clamps

- All models, JIC-8
- Special connection fittings are available on request.

- Attach connection hoses to fittings as shown in the chapter 3.6. Make sure that hoses do not twist when tightening the fittings.
- Motor connections are conical and fitted with teflon rings, recommend not to use tightening torques exceeding 60 Nm.
- Check that the hose lengths are correct. Check that the hoses are not pressed or chafed by any of the lift mast or attachment components.
- Do not use a smaller hose-bending radius than recommended by the hose manufacturer.

CAUTION !!!

Do not over-tighten the hose fittings.

3.6 Hydraulic Connections

Hydraulic connection points for the clamping and opening functions can be mounted on the left side (standard) or right side (optional). Rotator hydraulic connections are always on the right side.

Standard connection points are as follows:

- Clamping & opening on the left side (as seen from the driver's seat)
- Rotation on the right side

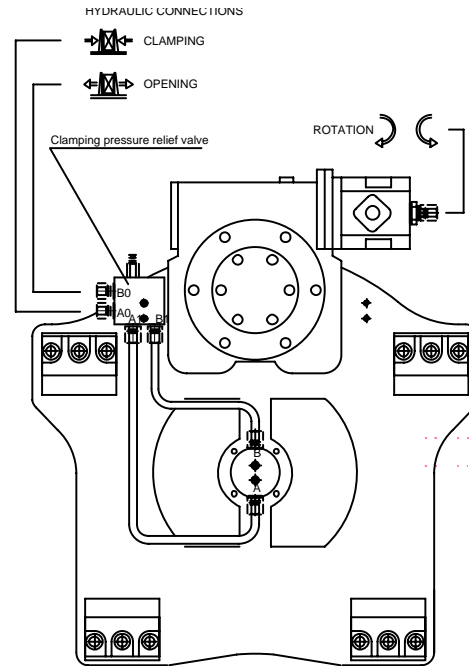

Figure: Standard hydraulic connections

Optional connection points are as follows:

- Clamping & opening on the right side (as seen from the driver's seat)
- Rotation on the right side

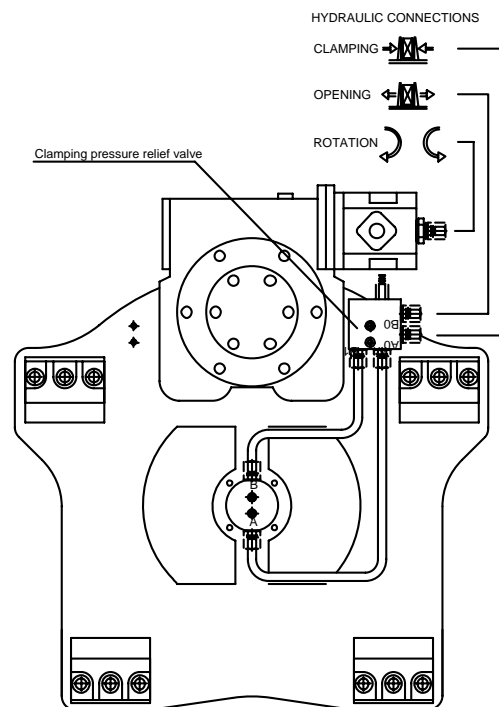

Figure: Optional hydraulic connections

3.7 Hydraulic Connection Options, Opening Pressure Relief Valve

An optional pressure relief valve for arm opening is available on request. This option must be selected if the lift truck pressure exceeds the maximum connection pressure of 18.0 MPa (180 bar / 2,600 psi).

The valve is available for both left and right side assembly.

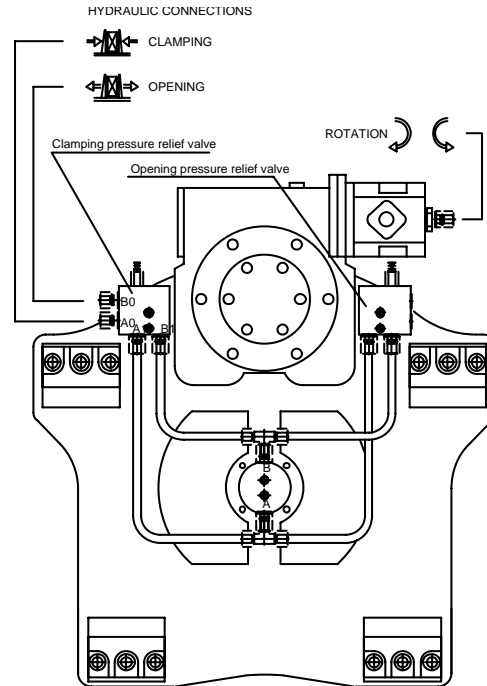

Figure: Optional opening pressure relief valve, connections left

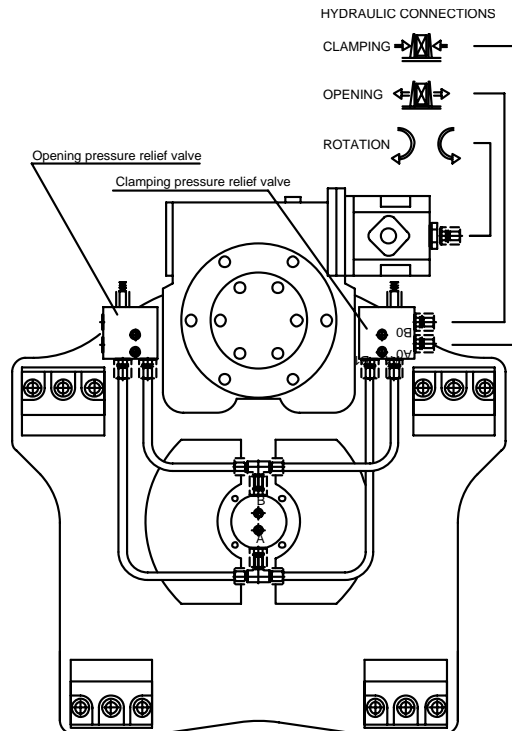

Figure: Optional opening pressure relief valve, connections right

3.8 Air Removal

Air in the hydraulic system can cause extra flex or movements in clamp functions.

- Remove air by carrying out all movements (clamping and sideshift) several times between respective end positions.

WARNING !!!

Clamp arms can move unpredictably if there is air in the system.

3.9 Checks Before Operating the Clamp

Check the mounting and all functions of the clamp before using it for the first time.

3.9.1 Mounting and Clamp Mechanics

- Check all parts of the clamp to see that no damage occurred during the transportation.
- Check that there are no loose bolts or joints.
- Check that installation on the truck is correct.
- Check that the clamp is centered on the truck.

3.9.2 Hydraulic Parts

- Wipe clean all hydraulic parts.
- Check truck oil level.
- Run all movements (clamping and rotation) several times between respective end positions.
- Check all cylinders, valves, hoses and fittings for any leaks.
- Check that hosing is correct also when pressurized.

3.9.3 Clamping Force Test

It is recommended that regular clamping force tests are carried out in order to minimize the possibility of load damage. This is especially important with paper roll clamps and other clamps handling sensitive loads.

- Check clamping force by using the Bolzoni Auramo Test Pad, Test Stand, Test Cylinder or any other suitable device.
- Check that the clamping force is maintained when clamping for an extended time period. Leave the pressure on for 5-10 minutes and check for the loss of pressure. Clamping force may decrease up to 10% in ten minutes maximum.

3.9.4 Action Test

- If possible test all clamp attachment functions with an actual load.
- Check the hydraulic system for any leaks or other problems.
- Check that the clamping force is correct for the load.

3.9.5 Operation Times

It is difficult to give exact values for clamping and sideshift times because the available pump flow volume affects movement speeds. Thus the values given below should be considered as guidelines only.

Clamping max-min	4-10 seconds, depending on the clamp size
Opening min-max	4-10 seconds, depending on the clamp size
Rotation	15-30 seconds, depending on the clamp size

If measured operation times are much slower than given values, check all hydraulic system connections and the pump flow volume. If necessary, contact your Bolzoni Auramo representative.

4. User Instructions

This section gives some basic instructions on how to handle loads with AM Series clamp attachment models.

4.1 General Instructions

Using the lift truck

Only trained and authorized operators may use the lift truck and the clamp attachment.

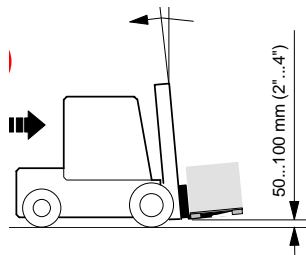

Driving with the load

Drive carefully and safely. Avoid strong acceleration and braking. Always drive with the load lowered down and, if possible, the mast tilted backwards. **No speeding! No overloading!** - consult the lift truck nameplate for available lifting capacity!

Parking

Always lower the load (and attachment) down when parking. Shut the power off and set the brakes on when leaving the truck unattended.

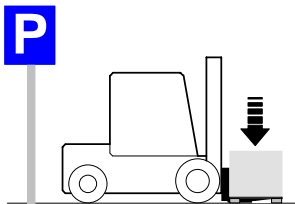

Loading

When taking a load or pallet from a stack, back away only so far as to be able to lower the load safely. Never accelerate or brake powerfully when the load is up, as this can lead to loss of balance.

Use extreme care when sideshifting, rotating or tilting raised loads.

Do not overload the lift truck – clamp combination!!!

Rotating

Do not risk the lift truck stability with rotation. Rotate only when the load is lowered down or near its seat. Use extreme caution when handling off-centered loads.

4.2 Short Arm Operation (Model AM-RH only)

Model AM-RH has a hydraulically positionable short arm.

The short arm opening can be changed when the clamp is rotated to a 45-degree angle, with the short arm facing downwards. In this position the oil flow to the long arm cylinder is closed and the short arm can be moved using the clamping lever.

When the clamp is rotated to vertical or horizontal handling position, only the long arm can be moved.

If the clamp is rotated to a 45-degree angle, with short arm facing upwards, both arms are stopped.

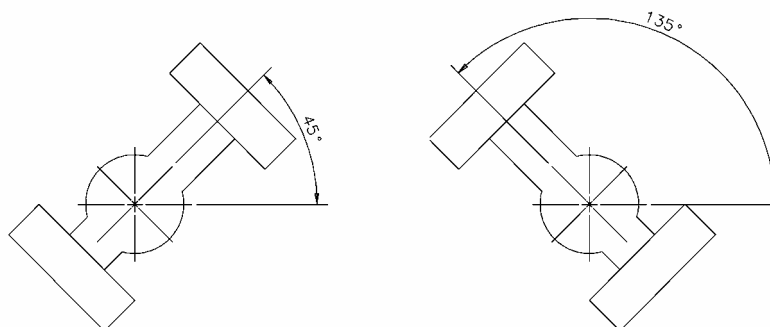
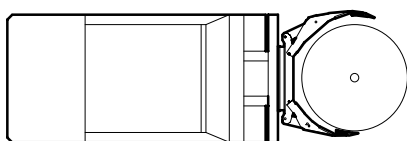

Figure: Rotation positions for moving the short arm

4.3 Paper Roll Handling

4.3.1 Clamping a Vertical Roll



Center the clamp in relation to the paper roll.

Big rolls - Open both arms fully. Drive the truck near the roll into a position where the short arm just touches the roll and the roll leans against the clamp body.

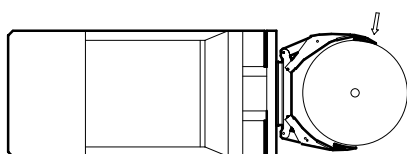

Small rolls - Close the short arm fully, open the long arms sufficiently. Drive the truck near the roll into a position where the short arm just touches the roll.

Clamp the roll by closing the long arm. Hold on closing for a couple of seconds to ensure necessary clamping force. Do not pump the valve.

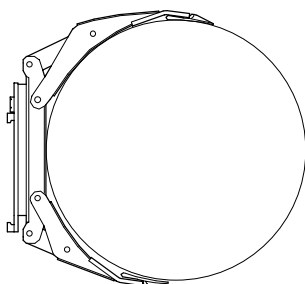

Clamp big rolls (= max diameter to max diameter - 10%) in such a way that the roll touches the clamp body and contact pads.

Smaller rolls must be clamped so the center of the roll would be on a line that goes through the contact pad center-points.

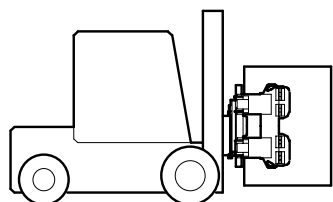

Do not clamp the roll too much behind its centerline, as the roll can easily slip off the clamp. Furthermore, do not clamp any roll too far in front of its centerline, as this can lead to the clamp frame and the contact pad corners damaging the roll.

Always clamp the roll so that the clamp attachment is aligned to the roll. Misalignment easily leads to roll damage. When handling singular rolls,

always grip the roll so that the arms are centered between the ends of the roll.

4.3.2 Clamping a Horizontal Roll

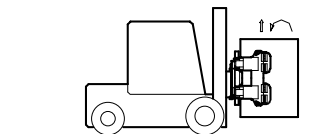
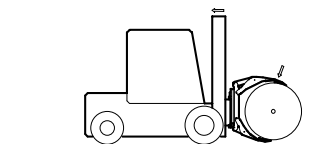
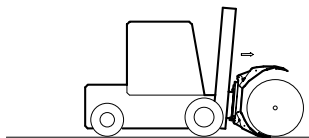
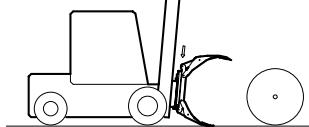
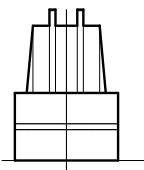
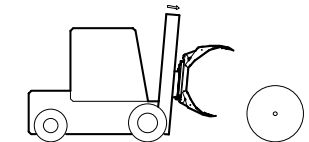
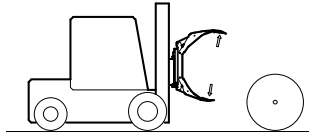

- Adjust the opening of the short arm to suit the diameter of the roll. Open long arm sufficiently. Turn short arm down, long arm up.
- Tilt the mast completely forward (ca. 5 - 6 degrees).
- Carefully adjust the truck so that the clamp is centered to the roll.
- Slowly lower the clamp until the short arm just touches the floor.
- Slowly approach the roll and stop when the lower contact pad touches the roll.
- Clamp the roll with the long arm. Tilt the mast back to the vertical position.
- Lift the roll and then rotate it to the vertical position. Take care not to damage the roll edges during rotation.

WARNING !!!

Never drive with roll in horizontal position. Lift the roll high enough before rotating. Keep roll ca. 30 cm (1 ft.) above the floor when driving.

Do not rotate off-centered rolls. Always clamp from the middle of the roll.

4.4 Tips for Safe Operation

Clamp the roll correctly.

Drive carefully and safely. Avoid strong acceleration and braking.

Always drive with the load lowered down and the mast in a vertical or backward-tilt position. Note that too much tilt backward or forward increases the risk of roll edge damage.

When taking a roll from the stack, back away only so far as to be able to lower the roll safely. Never accelerate or brake powerfully when the roll is up, as this can lead to loss of balance.

Do not release the roll before it is in its place. Never allow the roll to fall down.

Beware of slackness in the mast chains when lowering the load.

WARNING !!!

Always work safely.

Do not stand in the lift truck operating area or in front of the moving direction.

Never stand under a load or clamp attachment.

Do not lift more than one paper roll at a time.

5. Periodic Maintenance

5.1 Daily Checks

Check that there are no leaks, worn hoses or loosened parts in the clamp. Check the clamp frame and arms for defects or cracks.

Check that there are no sharp edges on such parts that come into contact with the load. Remove any such edges, for example, by grinding them.

Check all arms and contact pads and clean them if necessary. Contact pads should move easily when tested by hand.

Check that the clamping force is correct for your load. If needed, adjust clamping pressure to suit your needs. Never exceed a clamp's maximum operating pressure.

WARNING !!!

Always check the clamp operating condition before you use it. Never use a defective or damaged clamp.

Never exceed the maximum operating pressure.

5.2 Inspection and Service

WARNING !!!

In the following service actions the clamp is to be moved hydraulically. Do not leave any body parts between moving clamp attachment parts.

Do not remove pressurized parts.

Beware of part movements when removing hoses or pipes.

Do not climb on the clamp.

Carry out the following checks and **services twice a year or every 200 hours**, (whichever comes first).

- Clean the clamp
- Carry out all routine tasks mentioned in Section 5.1
- Inspect the oil level in the primary reduction gear unit. Top up if necessary.

- Apply grease to the rotation bearing. Remember to rotate the clamp during this operation. Wipe off all excessive grease.
- Protect all such moving parts that are susceptible to rust (such as springs and pull rods). Apply grease to arm pivot pin bearings and cylinder pivot pin bearings. Wipe off all excessive grease.
- Check contact pads, contact pad pull rods, contact pad springs and wear plates.
- Check the clamp for parts that might become defective or cause other trouble during the next service interval. Especially check arm pivot pins and their bushings, contact pads and wear plates. Check rotation bearing screws and mounting components. Replace or repair all parts showing signs of excessive wear or defects.

Arm pivots (pins, bushings and their seats)

- When moving arms up and down by hand, the play in the arm bearing bushings should be less than 5 mm (0.2 inch) measured from 1000 mm (40-inch) arm length. If the play is greater than this, and disturbs normal operations, replace the bushings.

5.3 Tightening the Bolts

Most bolts on Bolzoni Auramo AM Series clamps are secured using LOCTITE 270. Bolts under high stresses are also tightened to a certain fastening torque. Normally retightening of the bolts is unnecessary.

Should loose bolts be found during daily checks, open them, apply some LOCTITE 270 to the bolt threads and retighten them. Also remember to check the tightness of bolts within the immediate area.

Please refer to the spare parts book for correct fastening torques.

5.4 Lubricants (Greases)

The following lubricants are to be used on lubrication points on Bolzoni Auramo AM Series clamps:

Arm pivot bearings, cylinder pivot bearings:

- Mobil Mobilux EP2 / AGIP GR MU/EP2 (or other equivalent good quality grease)

Rotation bearing:

- Mobil Mobilux EP2 / ESSO Beacon EP2 / Shell Calithia EP Fett T2 / AGIP GR MU/EP2 (or other equivalent good quality grease)

Primary reduction gear:

- AGIP BLASIA 307 (or other equivalent good quality oil)

Secondary gear:

- Mobilux EP2 / AGIP GR MU/EP2 (or equivalent good quality grease)

6. Hydraulic System & Trouble Shooting

6.1 General

It is estimated that up to 80% of all problems and defects in hydraulic systems originate from dirty hydraulic oils.

In most cases, dirty oil is the reason for various valve problems and excessive wear in seals and o-rings.

Because all clamp attachment hydraulic functions move back and forth, it is possible that the same debris might be moving in the oil for a very long time unless special attention is paid to cleanliness.

Bolzoni Auramo strongly recommends that the hydraulic oil and oil filters be changed regularly.

6.2 Safety Warnings

During all troubleshooting operations, work will be carried out near the clamp. Always work safely.

WARNING !!!

Do not open pressurized components.

Hydraulic components can be hot. Use suitable protection.

Beware of leaks. High-pressure oil can damage the eyes and skin. Always wear protection goggles having side-protection.

Do not remove cartridge valves when pressure is on.

Do not put your body parts between or near moving clamp parts.

Do not climb on the clamp.

6.3 Hydraulic System

The standard hydraulic system consists of two separate parts

- clamping hydraulics
- rotation hydraulics

A pressure relief valve for clamping is included into the standard delivery.

Optional pressure relief valve is available for arm opening.

Modifications to the standard hydraulic system are possible, therefore always check the spare parts documentation supplied with the clamp.

6.3.1 Clamping Hydraulics, Model AM-RF, standard

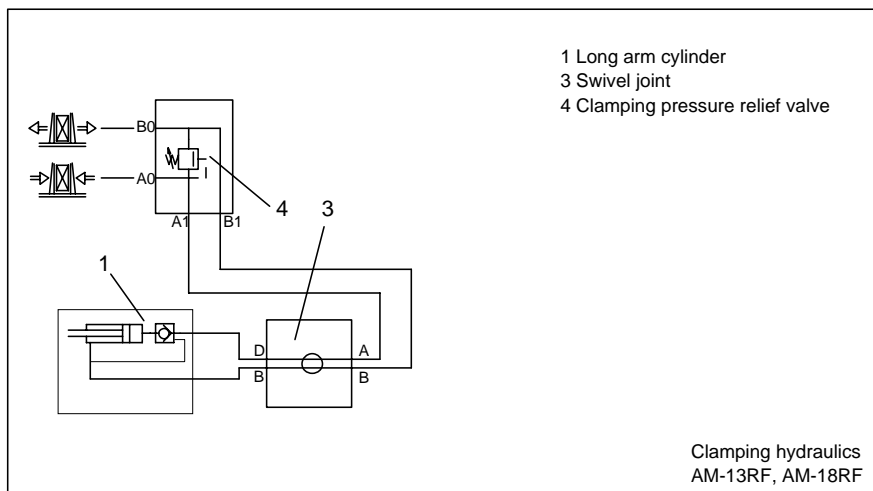

6.3.2 Clamping Hydraulics, Model AM-RH, standard

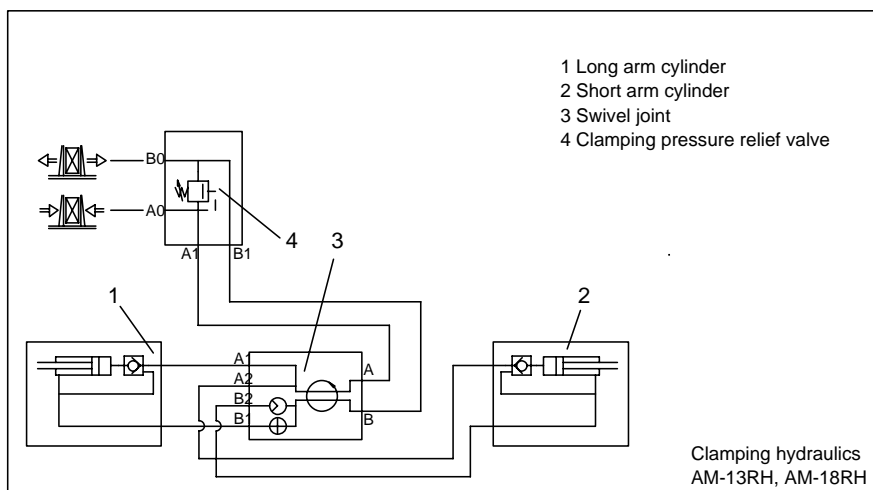

6.3.3 Clamping Hydraulics, Model AM-RF, with optional opening pressure relief valve

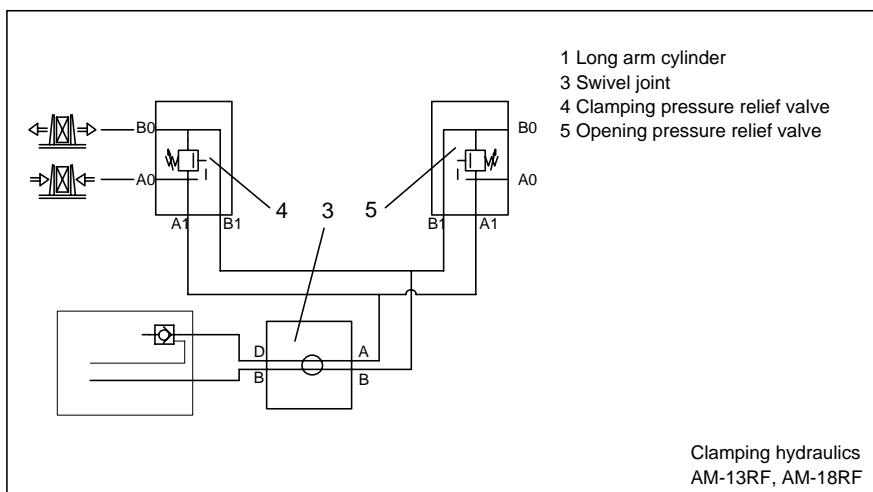

6.3.4 Clamping Hydraulics, Model AM-RH, with optional opening pressure relief valve

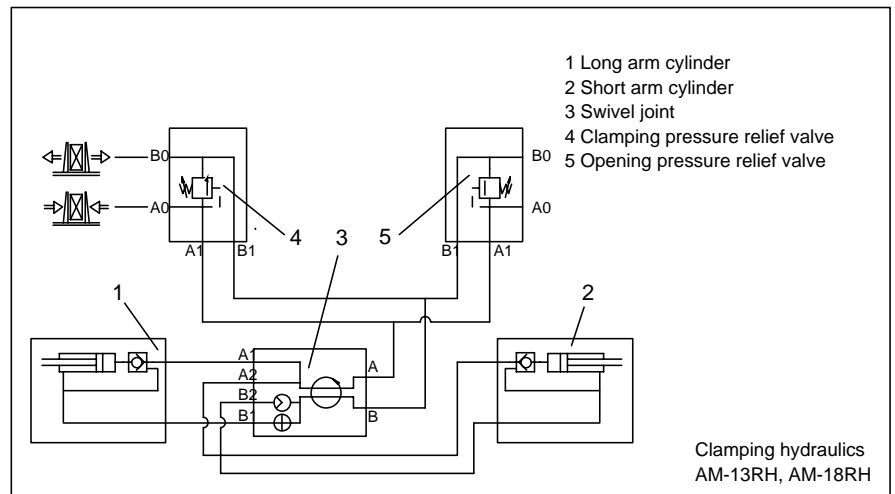

6.3.5 Rotation Hydraulics, Model AM-RF, AM-RH, standard rotation

Standard rotator unit does not have a pressure relief valve. If the lift truck pressure exceeds the maximum connection pressure, a separate pressure relief valve must be used.

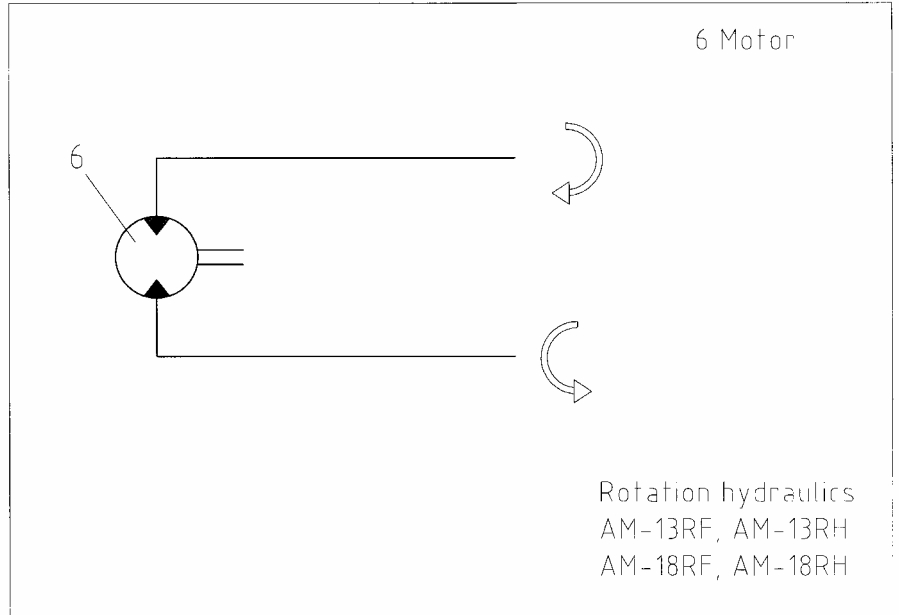

6.3.6 Swivel joint

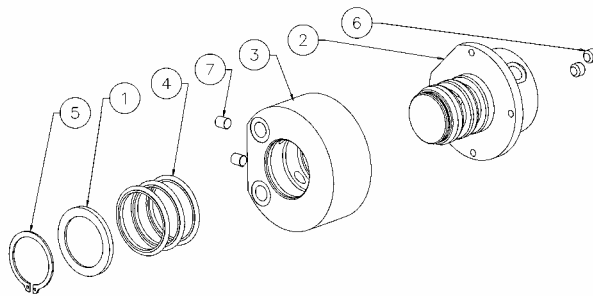
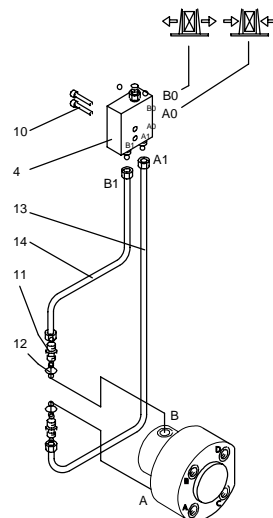

Figure: Swivel joint



Photo: Swivel joint

6.3.7 Clamping pressure relief valve, with connection tubes



6.3.8 Clamping cylinder

Clamping cylinder incorporates a check valve and a pressure check point.

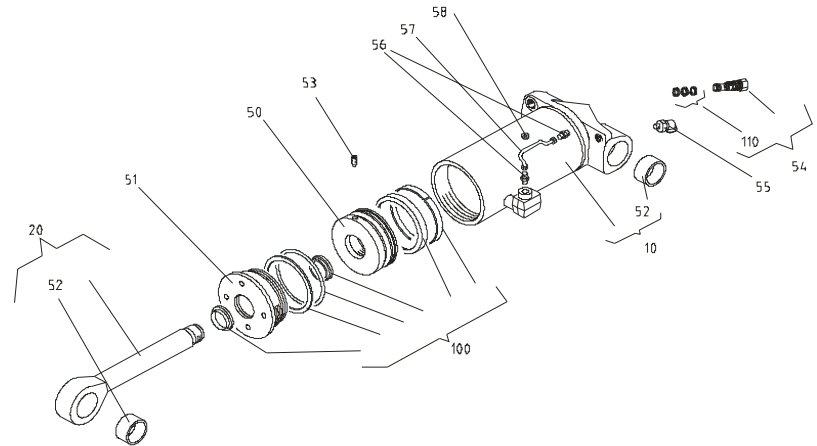

Figure: Clamping cylinder

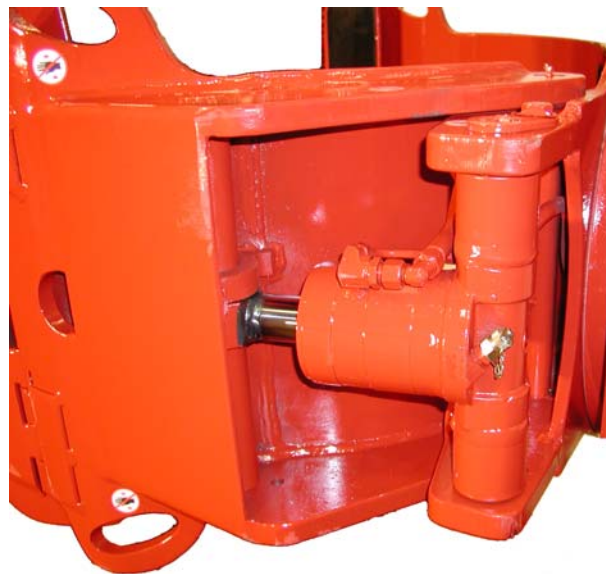

Photo: Clamping cylinder

6.4 Trouble Shooting

Problem: No pressure in the clamp

Possible cause: Hose connection between the clamp and truck is defective

- Check all connections. If needed, replace them.

Possible cause: Failure in the truck hydraulic system

- Check that oil is coming from truck hydraulic system.

Problem: Pressure is on, arms do not move

Possible cause: Incorrect hose connection

- Check the hoses. Rectify connections if needed.

Possible cause: Dirt in check valve

- Clean or replace check valves.

Possible cause: Pressure-relief valve defective or wrongly set

- Replace valve or correct the setting.

Possible cause: Leak in pressure cylinders

- Check and replace seals if needed.

Problem: Clamping force too small

Possible cause: Hydraulic pressure is too low

- Check truck pressure settings. Measure pressure coming from the truck. Pressure must be the same as, or higher than, what is required for the clamp.
- Check the oil level.
- Check for external leaks. If needed, clean components before examination.
- Blocked hose or fitting. Repair or replace.

Possible cause: Wrong setting in the main pressure-relief valve

- Check clamping pressure with the Bolzoni Auramo test cylinder. The pressure can be adjusted by turning the adjustment screw (clockwise - pressure increases, counterclockwise - pressure decreases). **Never exceed the maximum operating pressure of the clamp!**

Possible cause: Leak in check valve

- Clean or replace check valves or short arm pressure-relief valve.

Possible cause: Leak in cylinder seals

- Replace seals.
-

Possible cause: Too much pressure in tank line

- Check hoses and repair if needed.

Problem: Clamping force OK, load falls

Possible cause: Worn or dirty contact pad friction surfaces

- Clean or replace the contact pads.

Possible cause: Operator error

- Check that the load is clamped correctly and that there is no overloading.

Possible cause: Wrong clamp for the load

- Check if clamp capacity, arm opening range and arm models are suitable for the load.

Problem: Loss of clamping force

Possible cause: Leaks in hoses or fittings

- Check for external leaks. If needed, clean components before check.

Possible cause: Leak in check valve

- Clean or replace check valves.

Possible cause: Leak in cylinder seals

- Replace seals.

Problem: Clamp arms close or open too slowly

Possible cause: Oil flow from the pump is too small or much too high

- Check the pump and replace/repair it if needed. Note flow rate recommendation (see Section 3.1.3).

Possible cause: Defect in hoses or hoses are too small

- Repair or replace with correct sizes.

Problem: Arms move jerking/shaking

Possible cause: Air in the system

- Remove air by totally opening and closing arms several times.

Possible cause: Dirt in hydraulic system

- Clean system and change oil and oil filter.

Problem: Jerking/shaking rotation

Possible cause: Too heavy load or load too far out of the center

- Reduce the load weight or clamp the load from the center.

Possible cause: Excessive play in the gear unit

- Check the play between the pinion and the reduction unit. Repair or replace worn components.

Problem: Grease leaking out from the rotator

Possible cause: Worn out felt strip or excessive lubrication

- Wipe off all excessive grease. If necessary replace the felt strip. Use Bostik 524 2C glue for fastening the strip (or other similar good quality glue).

Problem: Oil leaking from the swivel joint

Possible cause: Worn out packing seals

- Check and replace.

Possible cause: Worn or loose hydraulic fittings

- Tighten and replace if necessary.

Problem: Noisy or vibrating operation of the rotation unit

Possible cause: Worn gear or gear bearings

- Verify that the play between the pinion and the toothed crown does not exceed 0.3 mm (0.012"). Verify that the play between the worm screw and the bronze gear does not exceed 0.1 mm (0.004").

7. Service and Repairs

7.1 General

Bolzoni Auramo and its authorized representatives are anxious to answer all customer questions concerning Bolzoni Auramo service and products.

To help us resolve any problem you may be having as fast and accurately as possible, please check the following information before contacting us:

Clamp attachment type, serial number and production year. This information can be found on the clamp nameplate.

How and under which operating conditions the trouble occurs.

Type of operation, estimated work hours of the clamp.

Any other information you think will help us to help you.

7.2 Notes on Service Actions

Clean the clamp carefully before removing or replacing any parts.

Protect the environment. Always put used oil into a proper tank.

Do not let dirt or debris enter into the hydraulic system. Always protect open fittings with a proper cap. Clean all parts carefully before installing them onto the clamp.

7.3 Service Instructions

In the following pages you will find instructions on how to perform such service actions and repairs that are outside the normal maintenance schedule.

WARNING !!!

Read instructions carefully before you do anything. Repairs done incorrectly are safety hazards.

Follow all safety instructions given in previous chapters.

7.3.1 Hose Change

- Clean the clamp carefully before removing or replacing any parts.
- If the hose leaks from the fitting, first try to tighten the fitting. Change the hose only if this does not help.
- Label all hoses before removing them. This makes re-assembly significantly easier.
- Protect all open fittings with a proper cap.
- Make sure that hose length is correct before installing it. Always compare the length of new and old hoses.
- Make sure that enough play length is left on the hose before fastening.
- Do not over-tighten hose fittings. Over-tightening will easily cause damage to valve blocks or fittings. Make sure that hoses do not twist when tightening the fittings.

WARNING !!!

Never remove or tighten pressurized parts or hoses.

7.3.2 Seal Change, Clamp Cylinders

- Remove hoses, protect open fittings with proper caps.

WARNING !!!

Never remove pressurized parts or hoses.

- Open the housing (51).
- Pull the piston assembly and housing (20, 51, 50) out of the cylinder shell (10).

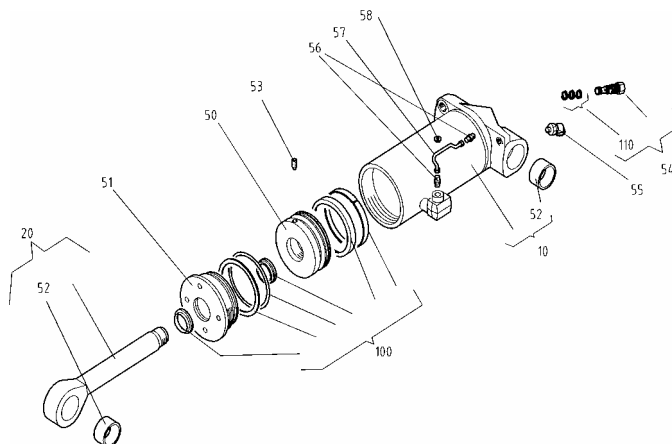

Figure: Clamp Cylinder

- Use a blunt screwdriver to take old seals away from the piston. If necessary cut the seals to remove them.

CAUTION !!!

Do not scratch piston surfaces with sharp tools.

Note the direction of the seals.

- Open the grub screw (53). If necessary, heat the screw before opening.
- Unscrew the piston (50) from the piston rod (20).
- Slide the housing (51) off the piston end of the rod.
- Remove old seals from housing.

CAUTION !!!

Do not scratch housing surfaces with sharp tools.

Note the direction of the seals.

- Clean and check piston, piston rod, cylinder shell and housing. See if there are any scratches, wear, corrosion, cracks or other similar defects that could prevent normal operation of the cylinder.
- Replace all damaged or worn parts.
- Install new seals to the housing.
- Lubricate seals and piston rod.
- Slide housing onto the rod from the piston end of the rod.
- Install the piston back onto the piston rod. Use LOCTITE 542 to secure the joint.
- Screw the grub screw back into the piston. Use LOCTITE 270 to lock the screw.

- Install new seals on the piston.
- Oil the cylinder shell.
- Slide piston assembly into the cylinder shell.
- Screw the housing into the cylinder shell.

- If possible, test run the cylinder before re-assembling it to the clamp. Max. test pressure is 22 MPa (220 bar, 3,200 psi).

- Re-install the cylinder to the clamp.
- Connect hoses.
- Test run all cylinder functions. Check for leaks.

8. Spare Parts

Bolzoni Auramo and its authorized dealers supply spare parts for all products manufactured by Bolzoni Auramo.

8.1 Spare Parts Book

A unique Spare Parts Book comes with each clamp attachment. This book consists of four main parts:

Machine Card

Includes attachment definitions as mentioned in the order. The Machine Card also contains the same information as the attachment nameplate.

Construction List

The Construction is a list of the main parts of the clamp attachment. It contains part numbers for sub-construction spare parts.

Spare Parts List

Contains part numbers and part quantities in sub-constructions.

Some parts contain other parts (for example clamp cylinders and valves) and have their own spare parts lists. These lists are referenced in the sub-construction spare parts list.

Make sure that correct part numbers are quoted, especially where a part number is dependent on part dimensions or pressure used in the system (such as clamp cylinders and valves).

Quality Control Report

Includes results from tests and inspections carried out during the final check.

8.2 Ordering Spare Parts

In order to ensure a fast and error-free ordering of spare parts, always include at least the following data with your order:

- Name
- Delivery address
- Possible order number

- Clamp type and serial number
- Spare parts number
- Quantity
- Delivery type

Unless otherwise specified in the order, Bolzoni Auramo will deliver spare parts in such a way as it finds suitable.

NOTE !!!

Spare Parts Books are unique for each clamp attachment. Always use the correct book when ordering spare parts.

Make sure that the serial number in the Spare Parts Book is the same as the one on the attachment nameplate.